

# K B<sup>®</sup> 3000

ELECTRONIC AMPLIFICATION SYSTEM

## O P E R A T I N G G U I D E





Intended to alert the user to the presence of uninsulated “dangerous voltage” within the product’s enclosure that may be of sufficient magnitude to constitute a risk of electric shock to persons.



Intended to alert the user to the presence of important operating and maintenance (servicing) instructions in the literature accompanying the product.

**CAUTION** Risks of electrical shock — DO NOT OPEN

**CAUTION** To reduce the risk of electric shock, do not remove cover. No user serviceable parts inside. Refer Servicing to qualified service personnel.

**WARNING** To prevent electrical shock or fire hazard, do not expose this appliance to rain or moisture. Before using this appliance, read the operating guide for further warnings.

---



Este símbolo tiene el propósito de alertar al usuario de la presencia de instrucciones importantes sobre la operación y mantenimiento en la literatura que viene con el producto.



Este símbolo tiene el propósito de alertar al usuario de la presencia de “(voltaje) peligroso” que no tiene aislamiento dentro de la caja del producto que puede tener una magnitud suficiente como para constituir riesgo de corrientazo.

**PRECAUCION** Riesgo de corrientazo - No abra.

**PRECAUCION** Para disminuir el riesgo de corrientazo, no abra la cubierta. No hay piezas adentro que el usuario pueda reparar. Deje todo mantenimiento a los técnicos calificados.

**ADVERTENCIA** Para evitar corrientazos o peligro de incendio, no deje expuesto a la lluvia o humedad este aparato. Antes de usar este aparato, lea más advertencias en la guía de operación.

---



Ce symbole est utilisé pour indiquer à l'utilisateur qu'il ou qu'elle trouvera d'importantes instructions sur l'utilisation et l'entretien (service) de l'appareil dans la littérature accompagnant le produit.



Ce symbole est utilisé pour indiquer à l'utilisateur la présence à l'intérieur de ce produit de tension non-isolée dangereuse pouvant être d'intensité suffisante pour constituer un risque de choc électrique.

**ATTENTION** Risques de choc électrique — NE PAS OUVRIR!

**ATTENTION** Afin de réduire le risque de choc électrique, ne pas enlever le couvercle. Il ne se trouve à l'intérieur aucune pièce pouvant être réparée par l'utilisateur. Confier l'entretien à un personnel qualifié.

**AVERTISSEMENT** Afin de prévenir les risques de décharge électrique ou de feu, n'exposez pas cet appareil à la pluie ou à l'humidité. Avant d'utiliser cet appareil, lisez les avertissements supplémentaires situés dans le guide d'utilisation.

---



Dieses Symbol soll den Benutzer auf wichtige Instruktionen in der Bedienungsanleitung aufmerksam machen, die Handhabung und Wartung des Produkts betreffen.



Dieses Symbol soll den Anwender vor unisolierten gefährlichen Spannungen innerhalb des Gehäuses warnen, die von Ausreichender Stärke sind, um einen elektrischen Schlag verursachen zu können.

**VORSICHT** Risiko - Elektrischer Schlag! Nicht öffnen!

**VORSICHT** Um das Risiko eines elektrischen Schlages zu vermeiden, nicht die Abdeckung entfernen. Es befinden sich keine Teile darin, die vom Anwender repariert werden könnten. Reparaturen nur von qualifiziertem Fachpersonal durchführen lassen.

**ACHTUNG** Um einen elektrischen Schlag oder Feuergefahr zu vermeiden, sollte dieses Gerät nicht dem Regen oder Feuchtigkeit ausgesetzt werden. Vor Inbetriebnahme unbedingt die Bedienungsanleitung lesen.

# ENGLISH

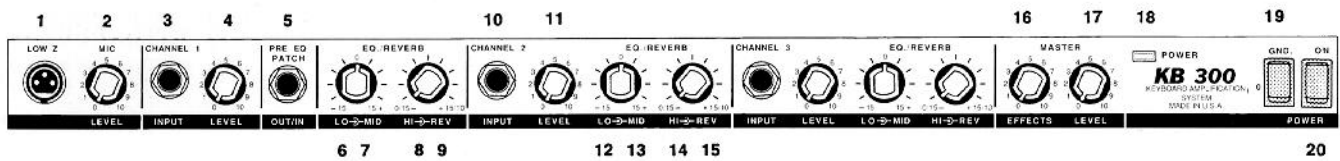

## LOW Z INPUT (1)

For use with low impedance microphones or low level sources equipped with a male XLR connector.

## LEVEL CONTROL (2)

Controls the channel volume.

## HIGH Z INPUT (3)

A ¼" phone jack input is provided with extremely "wide" dynamic range. This input will accept very high level signals generated by synthesized keyboard systems or very low signals generated by practice or home keyboard units.

## LEVEL CONTROL (4)

Controls the channel volume.

## PRE EQ PATCH (5)

A stereo Out/In jack provided for connecting external effects devices. A shielded "Y" cord (Peavey Part #0005299) with a ¼" stereo phone plug (ring, tip, and sleeve) branching into two ¼" mono phone plugs is required for this connection (insert fully). The "tip" of the stereo plug routes the signal to the effects device input. The effects device output is returned through the "ring." The "sleeve" is ground. The first click of this stereo jack can be used as a pre-EQ output without disturbing the signal flow to the remainder of the system.

**NOTE:** If the second click of the Out/In jack is utilized without returning any signal to the system from an effects device, the remaining preamp functions will be disabled.

## LOW EQ CONTROL (6)

An active tone control (shelving type,  $\pm 15$  dB) that varies the low frequency range.

**CAUTION:** Excessive low frequency boost causes greater power consumption and increases possibility of speaker damage.

## MID EQ CONTROL (7)

An active tone control (peak/notch,  $\pm 15$  dB) that adjusts the mid frequency range.

## HIGH EQ CONTROL (8)

An active tone control (shelving type,  $\pm 15$  dB) that varies the high frequency range.

## REVERB CONTROL (9)

Sets the level of the internal reverb (echo effect) for the channel and must be used in conjunction with the master effects level.

## HIGH Z INPUT (10)

A ¼" phone jack input is provided with extremely "wide" dynamic range. This input will accept very high level signals generated by synthesized keyboard systems or very low signals generated by practice or home keyboard units.

## LEVEL CONTROL (11)

Controls the channel volume.

### LOW EQ CONTROL (12)

An active tone control (shelving type,  $\pm 15$  dB) that varies the low frequency range.

**CAUTION:** Excessive low frequency boost causes greater power consumption and increases possibility of speaker damage.

### MID EQ CONTROL (13)

An active tone control (peak/notch,  $\pm 15$  dB) that adjusts the mid frequency range.

### HIGH EQ CONTROL (14)

An active tone control (shelving type,  $\pm 15$  dB) that varies the high frequency range.

### REVERB CONTROL (15)

Sets the level of the internal reverb (echo effect) for the channel and must be used in conjunction with the master effects level.

**NOTE:** Channel 3 functions are same as channel 2.

### MASTER EFFECTS (16)

Determines the overall effects level supplied to the internal reverb unit. This control works in conjunction with the channel reverb controls.

### MASTER LEVEL (17)

Controls the overall volume level of the system.

### POWER LED (18)

Illuminates when AC power is being supplied to the amp.

### GROUND SWITCH (19)

Three position rocker-type switch which, in most applications, should be operated in its center or zero position. There may be some situations when audible hum and/or noise will come from the loudspeaker. If this situation arises, position the ground switch to either positive or negative ( + or -) or until the noise is minimized.

**NOTE:** Should the noise problem continue, consult your Authorized Peavey Dealer, the Peavey Factory, or a qualified service technician. THE GROUND SWITCH IS NOT FUNCTIONAL ON 220/240 VOLT MODELS.

### POWER SWITCH (20)

Depress the switch to the "On" position. The red pilot light (LED) will illuminate indicating power is being supplied to the unit.

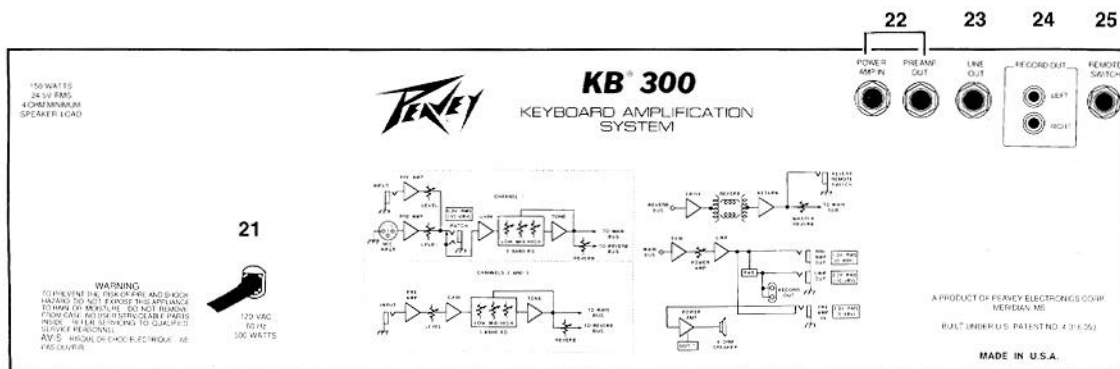

### LINE CORD (120 V PRODUCTS ONLY) (21)

For your safety, we have incorporated a 3-wire line (mains) cable with proper grounding facilities. It is not advisable to remove the ground pin under any circumstances. If it is necessary to use the equipment without proper grounding facilities, suitable grounding adaptors should be used. Less noise and greatly reduced shock hazard exists when the unit is operated with the proper grounded receptacles.

**PREAMP OUT/POWER AMP IN JACKS (22)**

These jacks are provided for in-line patching of effects devices. To patch an effects unit, connect the Preamp Output to the input of the device. Next, connect the output of the device to the Power Amp Input (high-quality shielded cables must be used for these connections). The Preamp Output can also be used to route the amplified signal to a mixing console, tape recorder, etc. Connect the Preamp Output, using a shielded cable, to an input of the tape recorder, mixer, etc. This patch does not affect the operation of the amplifier.

**NOTE:** The preamp output level is approximately 1 volt RMS and is of relatively low impedance (600 ohms). Any effects device used in this effects loop must be capable of receiving 1 volt input and providing 1 volt output in order to properly drive the power amp. The Power Amp Input has an internal switch which disconnects the internal preamp.

**LINE OUT (23)**

Routes the signal directly to mixing/recording consoles using special EQ to simulate loudspeaker response. A shielded cable must be used for connection. Refer to Specification Section.

**RECORD OUT LEFT AND RIGHT (24)**

RCA jacks are provided for recording directly from the main signal. The signal at this point is divided into dual output (left and right).

**REMOTE SWITCH JACK (25)**

For connection of a footswitch (optional) and is used to activate/defeat reverb.



# SPECIFICATIONS

## POWER AMP SECTION

### Rated Power & Load:

150 W RMS into 4 ohms with DDT™ compression

### Power @ Clipping: (Typically)

(1 kHz, 120 V AC line)  
155 W RMS into 4 ohms @ 1% THD  
165 W RMS into 4 ohms @ 5% THD

### Frequency Response:

+0, -2 dB, 30 Hz to 30 kHz, @ 140 W RMS into 4 ohms

### Total Harmonic

#### Distortion:

Less than 0.2%, 100 mW to 140 W RMS

### DDT™ Dynamic Range:

Greater than 20 dB

### DDT™ Maximum THD:

Below 0.6% THD for 6 dB overload  
Below 1% THD for 16 dB overload

### Hum & Noise:

Greater than 90 dB below rated power

### Power Consumption: (Domestic)

400 W @ 120 V AC, 50/60 Hz

## PREAMP SECTION

The following specs are measured at 1 kHz with all channel EQ flat at 0 dB, master effects set at 0 and master level set at 0. Nominal values are with levels at 5. Minimum values are with levels at 10.

### Low Z Microphone Input: (Unbalanced XLR)

Input impedance, 3.3 kilohms  
Nominal input level: -36 dBV, 15 mV RMS  
Minimal input level: -54 dBV, 2 mV RMS  
Maximum input level: Unlimited

### Instrument Inputs: (Phone Jack)

Input impedance: 33 kilohms  
Nominal input level: -16 dBV, 150 mV RMS  
Minimum input level: -34 dBV, 20 mV RMS  
Maximum input level: Unlimited

### Pre EQ Patch Out: (Stereo Phone Jack Tip)

Function: Low level effects send  
Input impedance: 10 kilohms or greater  
Nominal output level: -12 dBV, 0.25 V RMS

### Pre EQ Patch In: (Stereo Phone Jack Ring)

Function: Low level effects return  
Input impedance: 47 kilohms  
Designed input level: -12 dBV, 0.25 V RMS  
(Switching jack providing pre EQ patch out to pre EQ patch in connection when not used)

### Line Output: (Phone Jack)

Function: Low level post EQ send  
Load impedance: 10 kilohms or greater  
Nominal output level: -12 dBV, 0.25 V RMS (at the DDT™ limit of 150 W RMS output)  
Maximum output level: +6 dBV, 2 V RMS

### Record Output: (Dual RCA Jacks, Mono Signal)

Function: Source for external recorder  
Load impedance: 10 kilohms or greater  
Nominal output level: -12 dBV, 0.25 V RMS (at the DDT™ limit of 150 W RMS output)

Maximum output level: +6 dBV, 2 V RMS.

### Preamp Output: (Phone Jack)

Function: High level post EQ Send  
Load impedance: 1 kilohm or greater  
Nominal output level: 0 dBV, 1 V RMS (at the DDT™ limit of 150 W RMS output)  
Maximum output level: +18 dBV, 8 V RMS

### Remote Switch: (Phone Jack)

Function: Reverb defeat footswitch

The following specs are measured at nominal settings, all phone jacks terminated with 47 kilohms.

### Frequency Response:

(Channel input/preamp output @ 1 V RMS level)  
+0, -2 dB, 40 Hz to 20 kHz

### System Distortion:

(Channel in/preamp out, 40 Hz to 20 kHz @ 1 V RMS)  
Less than .05% THD, typically below .01%

### Preamp Hum & Noise:

-75 dBV (all 2 channel operation)

### Channel Equalization:

±15 dB @ 80 Hz & 8 kHz, shelving  
±15 dB @ 600 Hz, peak/notch

### Weight:

81 lbs.

### Dimensions:

27.750" H x 26" W x 13" D

### PATCH DIAGRAM

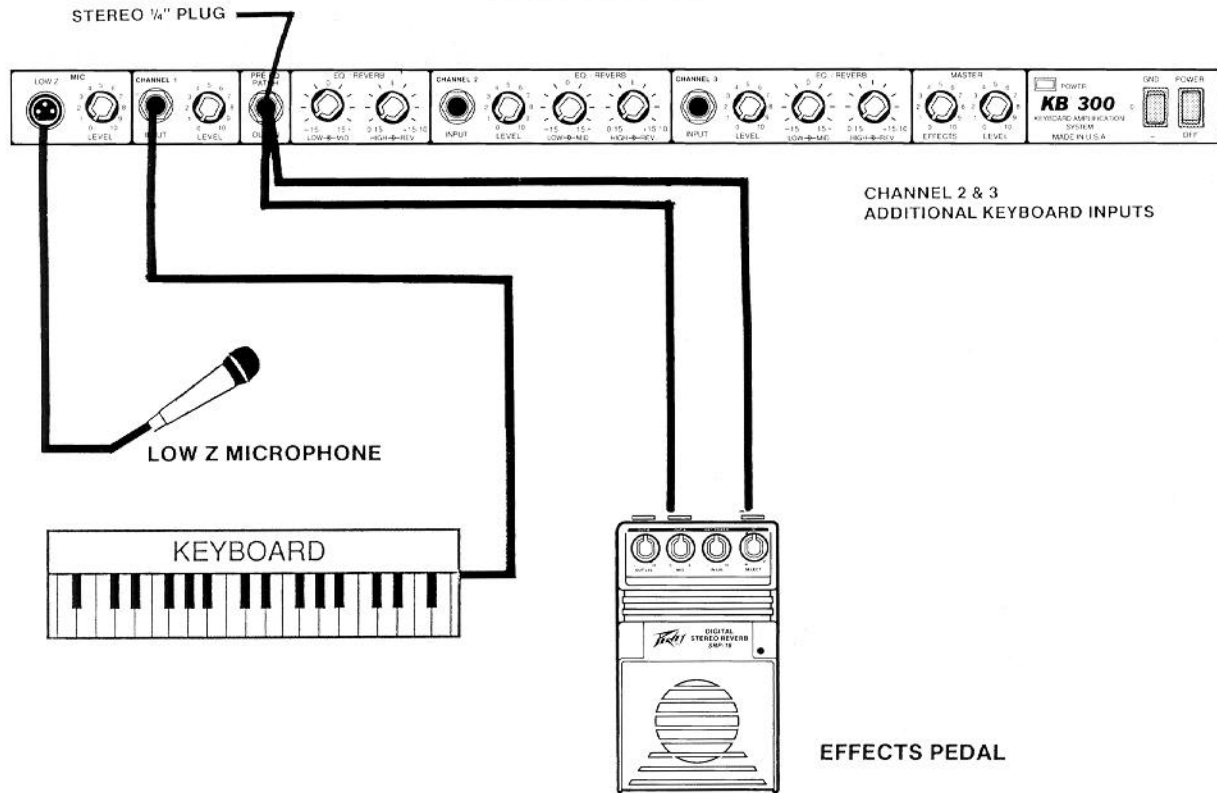

### PATCH DIAGRAM

BACK PANEL

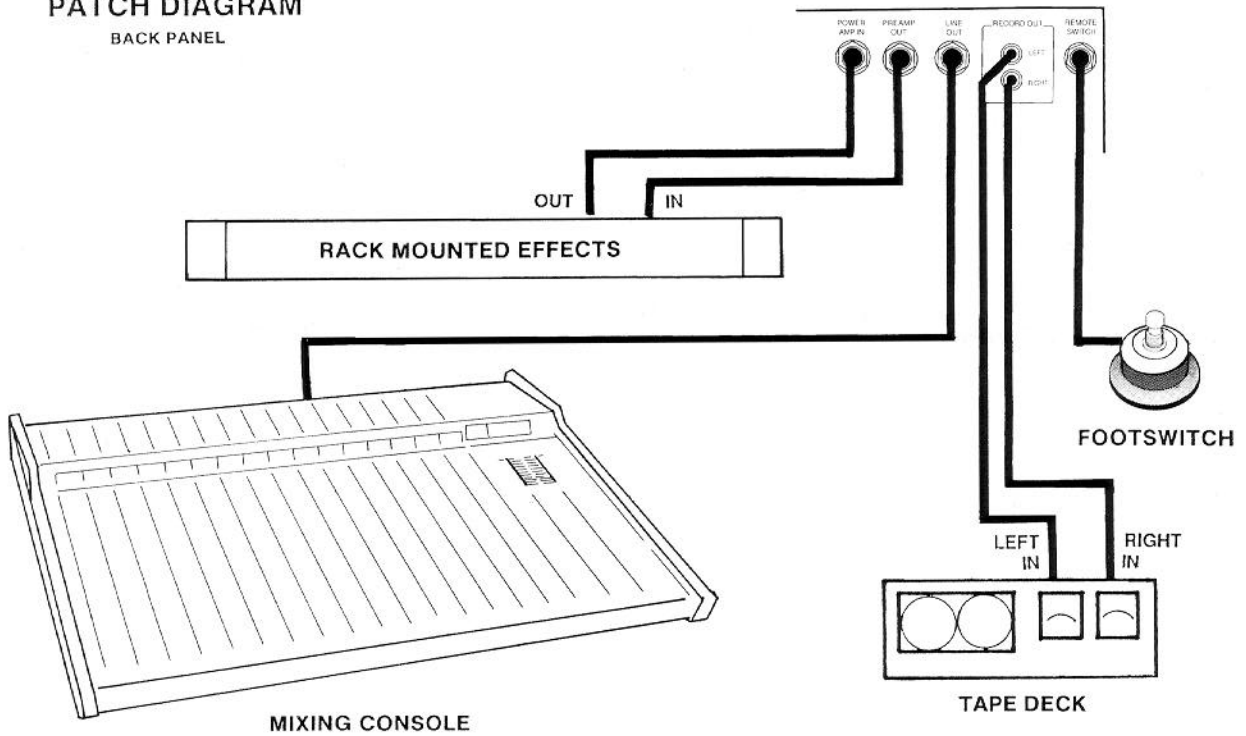

# ESPAÑOL

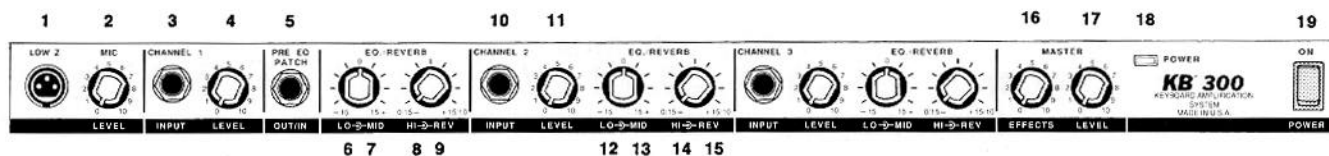

## **LOW Z INPUT (Entrada de baja impedancia) (1)**

Se usa con micrófonos de baja impedancia o fuentes de bajo nivel que estén equipados con clavijas tipo “XLR” macho.

## **LEVEL CONTROL (Control de nivel) (2)**

Controla el volumen del canal.

## **HIGH Z INPUT (Entrada de alta impedancia) (3)**

Se suministra un enchufe hembra de entrada de ¼ de pulgada con una variación dinámica extremadamente “amplia”. Esta entrada aceptará tanto señales de muy alto nivel, generadas por un equipo de teclados sintetizados, como señales muy bajas, generadas por teclados de aprendizaje o teclados sencillos de aficionados.

## **LEVEL CONTROL (Control de nivel) (4)**

Controla el volumen del canal.

## **PRE EQ PATCH (Enchufe hembra anterior al ecualizador) (5)**

Se suministra un enchufe hembra estereofónico “Out/In” para introducir aparatos externos de efectos directamente en los circuitos de los dos amplificadores. Para esta conexión se requiere un cable blindado tipo “Y” (pieza Peavey número 0005299) con una clavija monofónica de ¼ de pulgada (aro, punta, manga) (insertar completamente) del cual parten dos cables que terminan en dos clavijas monofónicas. La punta de la clavija estereofónica manda la señal a la entrada del aparato de efectos. La salida del aparato de efectos se devuelve a través del aro. La manga va a tierra. El primer retén de este enchufe hembra estereofónico puede ser utilizado como una salida pre-ecualizador sin alterar el flujo de la señal al resto del sistema. Inserte la clavija hasta escuchar el primer “click” (golpecito seco).

**NOTA:** Si el segundo retén en el enchufe hembra “Out/In” se utiliza sin devolver ninguna señal al sistema desde un aparato de efectos, las funciones de preamplificación quedarán desactivadas.

## **LOW EQ (Ecualizador de frecuencias graves) (6)**

Un control de tono activo (tipo shelving,  $\pm 15$  dB) que varía la gama de frecuencias graves.

**PRECAUCION:** Un impulso excesivo a las frecuencias graves produce mayor consumo de potencia y aumenta la posibilidad de dañar el altavoz.

## **MID EQ (Ecualización de frecuencias medias) (7)**

Un control activo de tono (gradual  $\pm 15$  dB) que ajusta las frecuencias medias.

## **HIGH EQ (Ecualizador de frecuencias agudas) (8)**

Control de tono activo (tipo “repisa”,  $\pm 15$  dB) que varía la gama de frecuencias agudas.

## **REVERB CONTROL (Control de reverberación) (9)**

Establece el nivel de la reverberación interna (efecto eco) para el canal y debe usarse conjuntamente con el control general de nivel de efectos.



### HIGH Z INPUT (Entrada de alta impedancia) (10)

Se suministra un enchufe hembra de entrada de ¼ de pulgada con una variación dinámica extremadamente “amplia”. Esta entrada aceptará tanto señales de muy alto nivel, generadas por un equipo de teclados sintetizados, como señales muy bajas, generadas por teclados de aprendizaje o teclados sencillos de aficionados.

### LEVEL CONTROL (Control de nivel) (11)

Controla el volumen del canal.

### LOW EQ (Ecuador de frecuencias graves) (12)

Un control de tono activo (tipo shelving, ±15 dB) que varía la gama de frecuencias graves.

**PRECAUCION:** Un impulso excesivo a las frecuencias graves produce mayor consumo de potencia y aumenta la posibilidad de dañar el altavoz.

### MID EQ (Ecuación de frecuencias medias) (13)

Un control activo de tono (gradual ±15 dB) que ajusta las frecuencias medias.

### HIGH EQ (Ecuador de frecuencias agudas) (14)

Control de tono activo (tipo “repisa”, ±15 dB) que varía la gama de frecuencias agudas.

### REVERB CONTROL (Control de reverberación) (15)

Establece el nivel de la reverberación interna (efecto eco) para el canal y debe usarse conjuntamente con el control general de nivel de efectos.

**NOTA:** Las funciones del canal 3 son iguales a las del canal 2.

### MASTER EFFECTS (Control maestro de efectos) (16)

Determina el nivel global de efectos que se suministra al equipo de reverberación interno. Este control funciona conjuntamente con los controles de reverberación de canales.

### MASTER LEVEL CONTROL (Control maestro de nivel) (17)

Controla el nivel global de volumen del sistema.

### POWER LED (LED indicador de corriente) (18)

Se ilumina cuando el amplificador recibe corriente alterna.

### POWER SWITCH (Interruptor de corriente) (19)

Oprima el interruptor a la posición “hacia dentro” (encendido). La luz roja del piloto (indicador) se encenderá indicando que la unidad está recibiendo corriente alterna.

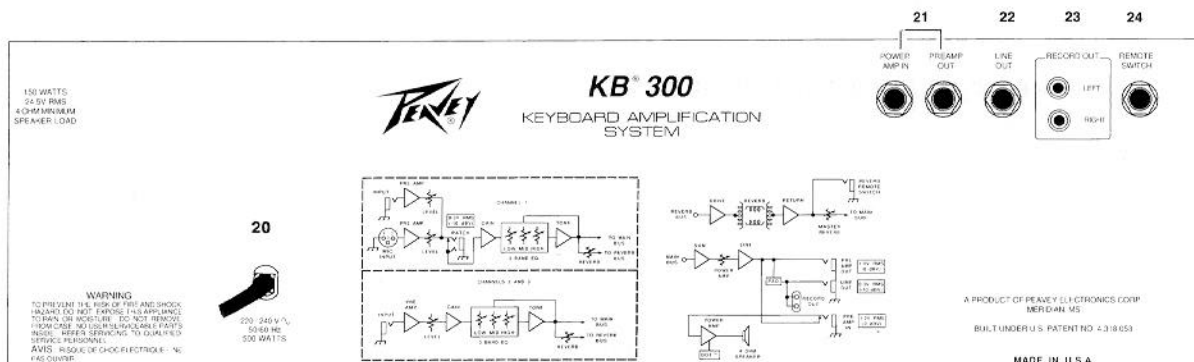

### LINE CORD (120 V PRODUCTS ONLY) (Cable de corriente para 120 v solamente) (20)

Para su protección hemos incorporado un cable de 3 polos con polo a tierra. No es recomendable remover la pata del polo a tierra bajo ninguna circunstancia, se recomienda un adaptador en caso necesario. Esto reducirá ruidos y peligrosos corrientazos.

**PREAMP OUT/POWER AMP IN (Salida del preamplificador/Entrada del amplificador de potencia) (21)**

Se suministran estos enchufes hembras para conectar aparatos de efectos en línea. Para conectar un aparato de efectos, conecte la salida del preamplificador a la entrada del aparato, después conecte la salida del aparato a la entrada del amplificador de potencia. (Para este tipo de conexión debe usar cables blindados de buena calidad.) La salida del preamplificador también se puede usar para mandar la señal a nivel de línea a una consola de mezcla, grabadora, etc. Esta conexión no afecta la función del amplificador.

**NOTA:** El nivel de salida del preamplificador es aproximadamente 1 voltio “RMS” y es de relativamente baja impedancia (600 ohms). Cualquier aparato de efectos que se use en este lazo de efectos debe ser capaz de recibir 1 voltio de entrada y proveer 1 voltio de salida para impulsar correctamente el amplificador de potencia. La entrada del amplificador de potencia tiene un interruptor interno que desconecta el preamplificador interno.

**LINE OUTPUT (Salida de línea) (22)**

Manda la señal directamente a las consolas de mezcla o grabadoras, utilizando ecualización especial para simular la respuesta de un altavoz. Se debe usar un cable blindado para la conexión. Ver la sección de especificaciones de los aparatos.

**RECORD OUT LEFT AND RIGHT (Salidas de grabación izquierda y derecha) (23)**

Se suministra enchufes hembras “RCA” para grabar directamente desde la señal principal. La señal en este punto está dividida en una salida doble (izquierda y derecha).

**FOOTSWITCH (Pedal interruptor) (24)**

Para la conexión de un pedal interruptor (opcional) y se usa para activar/desactivar la reverberación.

# FRANCAIS

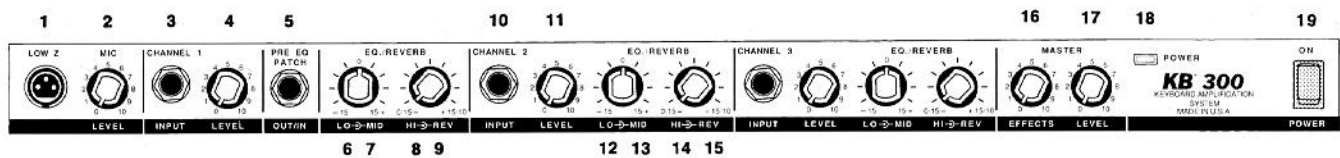

## **LOW Z INPUT (Entrée basse impédance) (1)**

À utiliser avec les microphones à basse impédance ou avec des sources à bas niveau munies d'une fiche XLR mâle.

## **LEVEL CONTROL (2)**

Contrôle le niveau de volume du canal.

## **HIGH Z INPUT (Entrée haute impédance) (3)**

Prise d'entrée jack ¼" (6,35 mm) à très grande bande dynamique. Cette entrée accepte les signaux de niveau très haut générés par les claviers/synthétiseurs ou les signaux de niveau très bas provenant des claviers de pratique ou des claviers domestiques.

## **LEVEL CONTROL (4)**

Contrôle le niveau de volume du canal.

## **PRE EQ PATCH (Boucle avant égalisation) (5)**

Prise jack stéréo (envoi/retour) servant à brancher des appareils d'effets externes. Un câble stéréo blindé de type "bretelle" (en Y) comportant un jack mâle stéréo ¼" (6,35 mm) d'un côté et deux jacks mono ¼" (6,35 mm) de l'autre côté doit être utilisé (pièce Peavey numéro #0005299). Insérez le câble bien à fond. Le signal d'envoi parvient à l'entrée de l'appareil d'effets par la pointe ("tip") du jack stéréo. Le signal de retour de l'appareil d'effets est reçu par l'anneau ("ring") du jack. Le manchon ("sleeve") sert pour la mise à la terre. Cette prise peut aussi servir de sortie avant égalisation ("Pre EQ") sans déranger le flot du signal dans le reste du système. Pour obtenir cette fonction, utilisez un jack mono ¼" (6,35 mm) et ne l'enfoncez qu'au premier cran seulement.

**NOTE:** Si un jack est enfoncé jusqu'au deuxième cran sans qu'un signal de l'appareil d'effet ne revienne au système, les autres fonctions du préampli seront supprimées.

## **LOW EQ (Égalisation grave) (6)**

Réglage de tonalité actif (type passe-bas,  $\pm 15$  dB), affectant les fréquences de registre grave.

**ATTENTION:** Une forte accentuation des fréquences graves augmente la consommation de puissance et les risques de dommages au haut-parleur.

## **MID EQ (Égalisation moyennes) (7)**

Réglage de tonalité actif (correction  $\pm 15$  dB) servant à ajuster les fréquences de registre moyen.

## **HIGH EQ CONTROL (Commande d'égalisation des fréquences aiguës) (8)**

Réglage de tonalité actif (type passe-haut,  $\pm 15$  dB) contrôlant les fréquences de registre aigu.

## **REVERB CONTROL (Réglage de réverbération) (9)**

Règle le niveau de la réverbération interne (effet d'écho) du canal et doit être utilisé conjointement avec le réglage "Master Effects".

### HIGH Z INPUT (Entrée haute impédance) (10)

Prise d'entrée jack ¼" (6,35 mm) à très grande bande dynamique. Cette entrée accepte les signaux de niveau très haut générés par les claviers/synthétiseurs ou les signaux de niveau très bas provenant des claviers de pratique ou des claviers domestiques.

### LEVEL CONTROL (11)

Contrôle le niveau de volume du canal.

### LOW EQ (Égalisation grave) (12)

Réglage de tonalité actif (type passe-bas,  $\pm 15$  dB), affectant les fréquences de registre grave.

**ATTENTION:** Une forte accentuation des fréquences graves augmente la consommation de puissance et les risques de dommages au haut-parleur.

### MID EQ (Égalisation moyennes) (13)

Réglage de tonalité actif (correction  $\pm 15$  dB) servant à ajuster les fréquences de registre moyen.

### HIGH EQ CONTROL (Commande d'égalisation des fréquences aiguës) (14)

Réglage de tonalité actif (type passe-haut,  $\pm 15$  dB) contrôlant les fréquences de registre aigu.

### REVERB CONTROL (Réglage de réverbération) (15)

Règle le niveau de la réverbération interne (effet d'écho) du canal et doit être utilisé conjointement avec le réglage "Master Effects".

**NOTE:** Les fonctions du canal 3 sont identiques à celles du canal 2.

### MASTER EFFECTS (Commande d'effets principale) (16)

Règle le niveau global de l'envoi d'effets allant à la réverbération interne. Ce réglage fonctionne conjointement avec les commandes de réverbération de canal ("channel reverb").

### MASTER LEVEL CONTROL (Commande de niveau principal) (17)

Contrôle le niveau de volume global du système.

### POWER LED (DEL témoin de mise sous tension) (18)

S'allume lorsque l'ampli reçoit l'alimentation CA.

### POWER SWITCH (Interrupteur d'alimentation) (19)

Mettre l'interrupteur en position "On". La lampe témoin rouge (DEL) s'illumine indiquant que l'appareil est alimenté en courant.

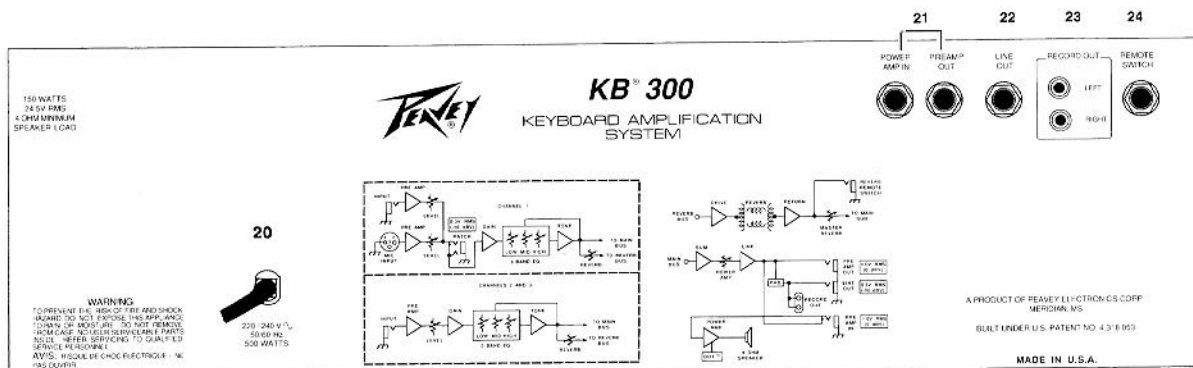

### LINE CORD (120V products only) (Cordon d'alimentation pour appareils 120V seulement) (20)

Pour votre sécurité, nous avons incorporé un câble d'alimentation secteur à 3 fils avec mise-à-terre appropriée. Il n'est pas recommandé d'enlever la broche de mise-à-terre en aucune circonstance. S'il est nécessaire d'utiliser l'équipement sans mise-à-terre appropriée, utilisez des adaptateurs de mise-à-terre convenables. Une bonne mise-à-terre amoindrit le bruit de fond et réduit grandement les risques de choc.

**PREAMP OUT/POWER AMP IN (Sortie préampli/entrée ampli) (21)**

Ces prises jack de boucle d'effets permettent l'insertion d'un appareil d'effets. Pour relier un appareil d'effets, branchez la sortie du préampli ("Preamp Output") à l'entrée de l'appareil. Branchez ensuite la sortie de l'appareil à l'entrée de l'ampli de puissance ("Power Amp Input"). Des câbles blindés de haute qualité doivent être utilisés pour ces connexions. La sortie "Preamp Output" peut aussi être utilisée pour amener le signal amplifié à une table de mixage, un magnétophone, ou autres. Branchez la sortie du préampli à l'entrée du magnétophone, mélangeur, etc, à l'aide de câbles blindés. Ce branchement n'affecte pas le fonctionnement de l'amplificateur.

**NOTE:** Le niveau de sortie du préampli est d'environ 1 volt sous impédance relativement basse (600 ohms). Les appareils d'effets insérés dans cette "boucle" doivent être capables de recevoir ce niveau d'entrée de 1 volt ainsi que de délivrer une sortie de 1 volt de façon à bien alimenter l'ampli de puissance. L'ampli de puissance possède un interrupteur interne qui débranche le préampli interne.

**LINE OUTPUT (Sortie ligne) (22)**

Dirige le signal directement à un pupitre de mixage ou d'enregistrement. Une égalisation spéciale est utilisée pour simuler la réponse de haut-parleurs de puissance. Utilisez un câble blindé pour le branchement. Voir la section "Specification".

**RECORD OUT LEFT AND RIGHT (Sorties gauche/droite pour enregistrement) (23)**

Prises jacks RCA permettant d'enregistrer directement à partir du signal principal. À ce point, le signal est divisé en deux sorties (gauche et droite).

**REMOTE SWITCH JACK (Prise pour interrupteur à distance) (24)**

Prise pour interrupteur au pied (en option). Cet interrupteur sert à activer ou désactiver la réverbération.



# DEUTSCH

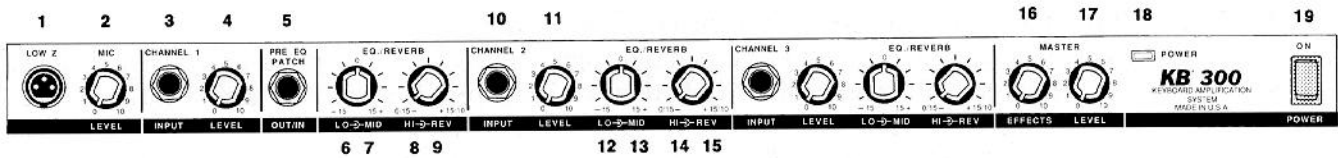

## LOW Z INPUT (1)

Zum Anschluß von niederohmigen Mikrofonen oder Geräten mit geringer Ausgangsspannung, die mit einem XLR-Stecker ausgerüstet sind.

## LEVEL CONTROL (2)

Regelt die Lautstärke des Kanals.

## HIGH Z INPUT (3)

Eine Klinkenbuchse mit extrem breitem Dynamikbereich für sehr hohe Eingangspegel von Synthesizer-Systemen oder sehr niedrige Pegel von Übungsverstärkern oder Heimkeyboards.

## LEVEL CONTROL (4)

Regelt die Lautstärke des Kanals.

## PRE EQ PATCH (5)

Diese Stereo Aus/Ein Buchse dient zum Anschluß externer Effektgeräte. Für diesen Anschluß wird ein abgeschirmtes Y-Kabel benötigt (Peavey Teile-Nr. -0005299) mit einer Stereo-Klinkenbuchse (Ring, Spitze, Schaft) welches in zwei Mono-Klinkenbuchsen übergeht (ganz einführen). Die Spitze der Stereo-Buchse führt das Signal zum Eingang des Effektgeräts. Der Effekt-Ausgang wird über den Ring zurückgeleitet. Der Schaft ist die Erdung. Der erste "Klick" dieser Stereobuchse kann als PreEQ-Ausgang verwendet werden, ohne den Signalfluß zum verbleibenden System zu stören.

**MERKE:** Wenn der zweite "Klick" der Aus/Ein Buchse benutzt wird, ohne das ein Signal von einem Effektgerät zum system zurückgeführt wird, schalten sich die verbleibenden Preamp Funktionen aus.

## LOW EQ (6)

Aktive Klangregelung für die tiefen Frequenzen. Anhebung und Absenkung im Bereich von  $\pm 15$  dB möglich. Achtung: Extreme Bassanhebung erfordert einen höheren Leistungsbedarf und kann evtl. zu einer Lautsprecherbeschädigung führen.

## MID EQ (Mitten-Klangregelung) (7)

Eine aktive Klangregelung mit Anhebung/Absenkung der Mittenfrequenzen um  $\pm 15$  dB.

## HIGH EQ (8)

Aktive Klangregelung für den hohen Frequenzbereich ( $\pm 15$  dB).

## REVERB CONTROL (9)

Stellt den Pegel des internen Halls (Echo Effekt) für den Kanal ein und muß in Verbindung mit dem Master Effekt Pegel benutzt werden.

## HIGH Z INPUT (10)

Eine Klinkenbuchse mit extrem breitem Dynamikbereich für sehr hohe Eingangspegel von Synthesizer-Systemen oder sehr niedrige Pegel von Übungsverstärkern oder Heimkeyboards.

### LEVEL CONTROL (11)

Regelt die Lautstärke des Kanals.

### LOW EQ (12)

Aktive Klangregelung für die tiefen Frequenzen. Anhebung und Absenkung im Bereich von  $\pm 15$  dB möglich. Achtung: Extreme Bassanhebung erfordert einen höheren Leistungsbedarf und kann evtl. zu einer Lautsprecherbeschädigung führen.

### MID EQ (Mid EQ) (Mitten-Klangregelung) (13)

Eine aktive Klangregelung mit Anhebung/Absenkung der Mittenfrequenzen um  $\pm 15$  dB.

### HIGH EQ (14)

Aktive Klangregelung für den hohen Frequenzbereich ( $\pm 15$  dB).

### REVERB CONTROL (15)

Stellt den Pegel des internen Halls (Echo Effekt) für den Kanal ein und muß in Verbindung mit dem Master Effekt Pegel benutzt werden.

**MERKE:** Die Funktionen von Kanal 3 entsprechen den Funktionen von Kanal 2.

### MASTER EFFECTS (16)

Legt den gesamten Effektpegel fest, der an die interne Reverb-Einheit geleitet wird. Dieser Regler arbeitet in Verbindung mit den Reverb Reglern dieses Kanals.

### MASTER LEVEL CONTROL (17)

Regelt die Gesamtlautstärke des Systems.

### POWER LED (18)

Zeigt die eingeschaltete Netzspannung an.

### POWER SWITCH (Netzschalter) (19)

Bringen Sie den Schalter auf die ON-Position. Die rote Kontrolllampe (LED) leuchtet und zeigt an, daß das Gerät eingeschaltet ist.

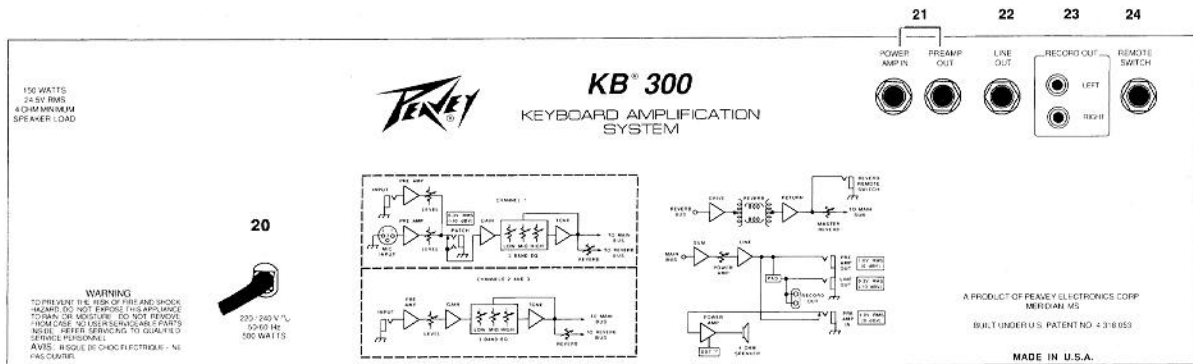

### LINE CORD (120V products only) (Nur bei 120 Volt-Geräten) (20)

Zu Ihrer Sicherheit haben wir das Gerät mit einem dreiadrigen geerdeten Netzkabel versehen. Es ist unter keinen Umständen empfehlenswert den Erdungskontakt des Anschlußkabels zu lösen. Falls es notwendig sein sollte, das Equipment ohne die vorgesehene Erdung zu betreiben empfiehlt sich die Verwendung eines Grounding Adaptors. Die geringsten Störgeräusche und die höchste Sicherheit vor elektrischen Schlägen wird jedoch durch die Benutzung der vorgesehenen Erdungsmöglichkeiten erreicht.

### **PREAMP OUT/POWER AMP IN (21)**

Diese Buchsen sind vorgesehen für das direkte Einschleifen von Effektgeräten. Um ein Effektgerät anzuschließen, verbinden Sie den Preamp-Output mit dem Eingang des Effektgerätes. Als nächstes verbinden Sie den Ausgang des Effekts mit dem Power Amp-Input (für diese Anschlüsse müssen abgeschirmte Kabel verwendet werden). Der Preamp Output kann auch dazu benutzt werden, ein verstärktes Signal direkt in einen Mixer oder eine Bandmaschine zu leiten. Verbinden Sie den Preamp Output über ein abgeschirmtes Kabel mit dem Eingang des Mixers oder der Bandmaschine. Diese Verbindung hat keinen Einfluß auf die Funktion des Verstärkers. Anmerkung: Der Pre-amp Output Vorverstärkerausgangspegel beträgt c. 1 Volt RMS bei 600 Ohm. Jedes Effektgerät, das hier eingeschleift werden soll, muß ein Eingangs- und Ausgangssignal von 1 Volt haben, um den Poweramp richtig anzusteuern. Der Poweramp-Eingang hat einen internen Schalter, der den internen Preamp trennt.

### **LINE OUTPUT (22)**

Leitet das Signal direkt an Mischpulte/Aufnahmegeräte unter Verwendung eines speziellen EQ der eine Lautsprechercharakteristik simuliert. Für diesen Anschluß muß ein abgeschirmtes Kabel verwendet werden. Unter SPEZIFIKATIONEN nachlesen.

### **RECORD OUT LEFT AND RIGHT (23)**

Um direkt vom Hauptsignal aufnehmen zu können, sind hierfür Cinch-Buchsen vorgesehen. Das Signal wird hier in links und rechts gesplittet.

### **REMOTE SWITCH JACK (Fuss-Schalter-Anschluss) (24)**

Zum Anschluß eines (optionalen) Fußschalters. Dient zum Ein- und Ausschalten des Halls.

**THIS LIMITED WARRANTY VALID ONLY WHEN PURCHASED AND REGISTERED IN THE UNITED STATES OR CANADA. ALL EXPORTED PRODUCTS ARE SUBJECT TO WARRANTY AND SERVICES TO BE SPECIFIED AND PROVIDED BY THE AUTHORIZED DISTRIBUTOR FOR EACH COUNTRY.**

**Ces clauses de garantie ne sont valables qu'aux Etats-Unis et au Canada. Dans tous les autres pays, les clauses de garantie et de maintenance sont fixées par le distributeur national et assurées par lui selon la législation en vigueur.**

**Diese Garantie ist nur in den USA und Kanada gültig. Alle Export-Produkte sind der Garantie und dem Service des Importeurs des jeweiligen Landes unterworfen. Esta garantía es válida solamente cuando el producto es comprado en E.U. continentales o en Canada. Todos los productos que sean comprados en el extranjero, están sujetos a las garantías y servicio que cada distribuidor autorizado determine y ofrezca en los diferentes países.**

**PEAVEY ONE-YEAR LIMITED  
WARRANTY/REMEDY**

PEAVEY ELECTRONICS CORPORATION ("PEAVEY") warrants this product, EXCEPT for covers, footswitches, patchcords, tubes and meters, to be free from defects in material and workmanship for a period of one (1) year from date of purchase, PROVIDED, however, that this limited warranty is extended only to the original retail purchaser and is subject to the conditions, exclusions, and limitations hereinafter set forth:

**PEAVEY 90-DAY LIMITED WARRANTY ON TUBES AND METERS**

If this product contains tubes or meters, Peavey warrants the tubes or meters contained in the product to be free from defects in material and workmanship for a period of ninety (90) days from date of purchase; PROVIDED, however, that this limited warranty is extended only to the original retail purchaser and is also subject to the conditions, exclusions, and limitations hereinafter set forth.

**CONDITIONS, EXCLUSIONS, AND LIMITATIONS OF LIMITED WARRANTIES**

These limited warranties shall be void and of no effect, if:

- a. The first purchase of the product is for the purpose of resale; or
- b. The original retail purchase is not made from an AUTHORIZED PEAVEY DEALER; or
- c. The product has been damaged by accident or unreasonable use, neglect, improper service or maintenance, or other causes not arising out of defects in material or workmanship; or
- d. The serial number affixed to the product is altered, defaced, or removed.

In the event of a defect in material and/or workmanship covered by this limited warranty, Peavey will:

- a. In the case of tubes or meters, replace the defective component without charge.
- b. In other covered cases (i.e., cases involving anything other than covers, footswitches, patchcords, tubes or meters), repair the defect in material or workmanship or replace the product, at Peavey's option; and provided, however, that, in any case, all costs of shipping, if necessary, are paid by you, the purchaser.

**THE WARRANTY REGISTRATION CARD SHOULD BE ACCURATELY COMPLETED AND MAILED TO AND RECEIVED BY PEAVEY WITHIN FOURTEEN (14) DAYS FROM THE DATE OF YOUR PURCHASE.**

In order to obtain service under these warranties, you must:

- a. Bring the defective item to any PEAVEY AUTHORIZED DEALER or AUTHORIZED PEAVEY SERVICE CENTER and present therewith the ORIGINAL PROOF OF PURCHASE supplied to you by the AUTHORIZED PEAVEY DEALER in connection with your purchase from him of this product.

If the DEALER or SERVICE CENTER is unable to provide the necessary warranty service you will be directed to the nearest other PEAVEY AUTHORIZED DEALER or AUTHORIZED PEAVEY SERVICE CENTER which can provide such service.

**OR**

- b. Ship the defective item, prepaid, to:

**PEAVEY ELECTRONICS CORPORATION**  
International Service Center  
326 Hwy. 11 & 80 East  
MERIDIAN, MS 39301

including therewith a complete, detailed description of the problem, together with a legible copy of the original PROOF OF PURCHASE and a complete return address. Upon Peavey's receipt of these items:

If the defect is remedial under these limited warranties and the other terms and conditions expressed herein have been complied with, Peavey will provide the necessary warranty service to repair or replace the product and will return it, FREIGHT COLLECT, to you, the purchaser.

Peavey's liability to the purchaser for damages from any cause whatsoever and regardless of the form of action, including negligence, is limited to the actual damages up to the greater of \$500.00 or an amount equal to the purchase price of the product that caused the damage or that is the subject of or is directly related to the cause of action. Such purchase price will be that in effect for the specific product when the cause of action arose. This limitation of liability will not apply to claims for personal injury or damage to real property or tangible personal property allegedly caused by Peavey's negligence. Peavey does not assume liability for personal injury or property damage arising out of or caused by a non-Peavey alteration or attachment, nor does Peavey assume any responsibility for damage to interconnected non-Peavey equipment that may result from the normal functioning and maintenance of the Peavey equipment.

**UNDER NO CIRCUMSTANCES WILL PEAVEY BE LIABLE FOR ANY LOST PROFITS, LOST SAVINGS, ANY INCIDENTAL DAMAGES, OR ANY CONSEQUENTIAL DAMAGES ARISING OUT OF THE USE OR INABILITY TO USE THE PRODUCT, EVEN IF PEAVEY HAS BEEN ADVISED OF THE POSSIBILITY OF SUCH DAMAGES.**

**THESE LIMITED WARRANTIES ARE IN LIEU OF ANY AND ALL WARRANTIES, EXPRESSED OR IMPLIED, INCLUDING, BUT NOT LIMITED TO, THE IMPLIED WARRANTIES OF MERCHANTABILITY AND FITNESS FOR A PARTICULAR USE; PROVIDED, HOWEVER, THAT IF THE OTHER TERMS AND CONDITIONS NECESSARY TO THE EXISTENCE OF THE EXPRESSED, LIMITED WARRANTIES, AS HEREINABOVE STATED, HAVE BEEN COMPLIED WITH, IMPLIED WARRANTIES ARE NOT DISCLAIMED DURING THE APPLICABLE ONE-YEAR OR NINETY-DAY PERIOD FROM DATE OF PURCHASE OF THIS PRODUCT.**

**SOME STATES DO NOT ALLOW LIMITATION ON HOW LONG AN IMPLIED WARRANTY LASTS, OR THE EXCLUSION OR LIMITATION OF INCIDENTAL OR CONSEQUENTIAL DAMAGES, SO THE ABOVE LIMITATIONS OR EXCLUSIONS MAY NOT APPLY TO YOU. THESE LIMITED WARRANTIES GIVE YOU SPECIFIC LEGAL RIGHTS, AND YOU MAY ALSO HAVE OTHER RIGHTS WHICH MAY VARY FROM STATE TO STATE.**

**THESE LIMITED WARRANTIES ARE THE ONLY EXPRESSED WARRANTIES ON THIS PRODUCT, AND NO OTHER STATEMENT, REPRESENTATION, WARRANTY, OR AGREEMENT BY ANY PERSON SHALL BE VALID OR BINDING UPON PEAVEY.**

In the event of any modification or disclaimer of expressed or implied warranties, or any limitation of remedies, contained herein conflicts with applicable law, then such modification, disclaimer or limitation, as the case may be, shall be deemed to be modified to the extent necessary to comply with such law.

Your remedies for breach of these warranties are limited to those remedies provided herein and Peavey Electronics Corporation gives this limited warranty only with respect to equipment purchased in the United States of America.

**INSTRUCTIONS — WARRANTY REGISTRATION CARD**

1. Mail the completed WARRANTY REGISTRATION CARD to:

**PEAVEY ELECTRONICS CORPORATION**  
POST OFFICE BOX 2898  
MERIDIAN, MISSISSIPPI 39302-2898

- a. Keep the PROOF OF PURCHASE. In the event warranty service is required during the warranty period, you will need this document. There will be no identification card issued by Peavey Electronics Corporation.
2. **IMPORTANCE OF WARRANTY REGISTRATION CARDS AND NOTIFICATION OF CHANGES OF ADDRESSES:**
  - a. Completion and mailing of WARRANTY REGISTRATION CARDS — Should notification become necessary for any condition that may require correction, the REGISTRATION CARD will help ensure that you are contacted and properly notified.
  - b. Notice of address changes — If you move from the address shown on the WARRANTY REGISTRATION CARD, you should notify Peavey of the change of address so as to facilitate your receipt of any bulletins or other forms of notification which may become necessary in connection with any condition that may require dissemination of information or correction.
3. You may contact Peavey directly by telephoning (601) 483-5365.

## IMPORTANT SAFETY INSTRUCTIONS

**WARNING:** When using electric products, basic cautions should always be followed, including the following.

1. Read all safety and operating instructions before using this product.
2. All safety and operating instructions should be retained for future reference.
3. Obey all cautions in the operating instructions and on the back of the unit.
4. All operating instructions should be followed.
5. This product should not be used near water, i.e., a bathtub, sink, swimming pool, wet basement, etc.
6. This product should be located so that its position does not interfere with its proper ventilation. It should not be placed flat against a wall or placed in a built-in enclosure that will impede the flow of cooling air.
7. This product should not be placed near a source of heat such as a stove, radiator, or another heat producing amplifier.
8. Connect only to a power supply of the type marked on the unit adjacent to the power supply cord.
9. Never break off the ground pin on the power supply cord. For more information on grounding, write for our free booklet "Shock Hazard and Grounding."
10. Power supply cords should always be handled carefully. Never walk or place equipment on power supply cords. Periodically check cords for cuts or signs of stress, especially at the plug and the point where the cord exits the unit.
11. The power supply cord should be unplugged when the unit is to be unused for long periods of time.
12. If this product is to be mounted in an equipment rack, rear support should be provided.
13. Metal parts can be cleaned with a damp rag. The vinyl covering used on some units can be cleaned with a damp rag or an ammonia-based household cleaner if necessary. Disconnect unit from power supply before cleaning.
14. Care should be taken so that objects do not fall and liquids are not spilled into the unit through the ventilation holes or any other openings.
15. This unit should be checked by a qualified service technician if:
  - a. The power supply cord or plug has been damaged.
  - b. Anything has fallen or been spilled into the unit.
  - c. The unit does not operate correctly.
  - d. The unit has been dropped or the enclosure damaged.
16. The user should not attempt to service this equipment. All service work should be done by a qualified service technician.
17. This product should be used only with a cart or stand that is recommended by Peavey Electronics.
18. Exposure to extremely high noise levels may cause a permanent hearing loss. Individuals vary considerably in susceptibility to noise induced hearing loss, but nearly everyone will lose some hearing if exposed to sufficiently intense noise for a sufficient time. The U.S. Government's Occupational Safety and Health Administration (OSHA) has specified the following permissible noise level exposures.

Duration Per Day In Hours	Sound Level dBA, Slow Response
8	90
6	92
4	95
3	97
2	100
1 1/2	102
1	105
1/2	110
1/4 or less	115

According to OSHA, any exposure in excess of the above permissible limits could result in some hearing loss.

Ear plugs or protectors in the ear canals or over the ears must be worn when operating this amplification system in order to prevent a permanent hearing loss if exposure is in excess of the limits as set forth above. To ensure against potentially dangerous exposure to high sound pressure levels, it is recommended that all persons exposed to equipment capable of producing high sound pressure levels such as this amplification system be protected by hearing protectors while this unit is in operation.

**SAVE THESE INSTRUCTIONS!**



**For further information on other Peavey products,  
ask your Authorized Peavey Dealer for the  
appropriate Peavey catalog/publication:**

**Bass Guitars**

**Guitars**

**Bass Amplification**

**Guitar Amplification**

**Sound Reinforcement Enclosures**

**Microphones**

**Keyboards**

**DJ**

**Lighting**

**Mixers, Powered/Non-Powered**

**Accessories/Cables**

**Effects Processors**

**Axcess™ Wear**

**The Peavey Beat™**

**Monitor® Magazine**

**Key Issues™**

**Low Down™**

**PM™ Magazine**



Features and specifications subject to change without notice.

**Peavey Electronics Corporation** 711 A Street / Meridian, MS 39301 / U.S.A. / (601) 483-5365 / Fax 486-1278

©1995

#80300977

Printed in U.S.A. 5/95